



NSAI

ECE TYPE-APPROVAL CERTIFICATE

E24

Communication concerning:²

- Approval granted
- ~~Approval extended~~
- ~~Approval refused~~
- ~~Approval withdrawn~~
- ~~Production definitely discontinued~~

of a type of device or system pursuant to UN Regulation No. 149

Class of the device: **F3** Change index: **0**
Approval No: **E24*149R00/05*0558*00**
Unique Identifier (UI) (If applicable) **N/A**
Reason(s) for extension (if applicable): **N/A**

1. Trade name or mark of the device or system:



2. Manufacturer's name for the type of device or system:

MS-BWP4

3. Manufacturer's name and address:



4. If applicable, name and address of manufacturer's representative:

N/A

5. Submitted for approval on:

05.06.2023

6. Technical Service responsible for conducting approval tests:

**TÜV SÜD Auto Service GmbH,
Westendstraße 199,
D-80686 München**

7. Date of report issued by that service:

27.05.2023

8. Number of report issued by that service:

23-01410-CX-SHA-00

¹ Distinguishing number of the country which has granted/extended/refused/withdrawn approval (see approval provisions in the Regulation).

² Strike out what does not apply.



NSAI

Approval No: E24*149R00/05*0558*00

9. Brief description:

9.1. For Headlamps of Classes A and B¹

- 9.1.1. Category as described by the relevant marking:³ N/A
 - 9.1.2. Number, category and kind of light source(s): N/A
 - 9.1.3. Reference luminous flux used for the principal passing-beam (lm): N/A
 - 9.1.4. Principal passing-beam operated at approximately (V): N/A
 - 9.1.5. Measures according to paragraph 4.12. of this Regulation: N/A
 - 9.1.6. Number and specific identification code(s) of LED module(s) and for each LED module a statement whether it is replaceable or not: *yes/no*¹ N/A
 - 9.1.7. Number and specific identification code(s) of electronic light source Control gear(s) N/A
 - 9.1.8. Total objective luminous flux as described in paragraph 4.5.6. of this Regulation exceeds 2,000 lumens: *yes/no/does not apply*¹ N/A
 - 9.1.9. The adjustment of the cut-off has been determined at: 10 m/25 m/does not apply¹ N/A
- The determination of the minimum sharpness of the "cut-off" has been carried out at: 10 m/25 m/does not apply¹ N/A

9.2. For headlamps of Class D

- 9.2.1. Headlamp/system submitted for approval as type:⁴ N/A

³ Indicate the appropriate marking selected from the list below:

C, C, C, R, R PL, CR, CR, CR, C/R, C/R, C/R, C/, C/, C/.

C, PL, C PL, C PL, CR PL, CR PL, CR PL, C/R PL, C/R PL, C/R PL.

C/PL, C/PL, C/PL

HC, HC, HC, HR, HR PL, HCR, HCR, HCR, HC/R, HC/R, HC/R, HC/, HC/, HC/.

HC PL, HC PL, HC PL, HCR PL, HCR PL, HCR PL, HC/R PL, HC/R PL, HC/R PL.

HC/PL, HC/PL, HC/PL

⁴ Indicate the appropriate marking selected from the list below:

DC, DC/, DC/PL, DR, DCR, DC/R, DC PL, DR PL, DCR DC/R

DC, DCR, DC/R, DC/, DC PL, DCR PL, DC/R DC/PL, PL, PL,

→ → → → → → PL →

→ → → → → →

DC, DCR, DC/R, DC/, DC PL, DCR PL, DC/R DC/PL,

↔ ↔ ↔ ↔ ↔ ↔ PL ↔

↔ ↔



NSAI

Approval No: E24*149R00/05*0558*00

- 9.2.2. The passing beam light source may/may not be lit simultaneously with the driving beam light source and/or another reciprocally incorporated headlamp. *N/A*
- 9.2.3. The rated voltage of the device is: *N/A*
- 9.2.4. Number, category and kind of light source(s): *N/A*
- 9.2.4.1. If more than one objective luminous flux value is specified: *N/A*
- Objective luminous flux value used for the principal passing beam *N/A*
- 9.2.4.2. If more than one objective luminous flux value is specified: *N/A*
- Objective luminous flux value used for the driving beam *N/A*
- 9.2.5. Trade name and identification number of separate ballast(s) or part(s) of ballast(s): *N/A*
- 9.2.6. The adjustment of the "cut-off" has been determined at 10 m/25 m.¹ *N/A*
- The determination of the minimum sharpness of the "cut-off" has been carried out at 10 m/25 m.¹ *N/A*
- 9.2.7. Number and specific identification code(s) of LED module(s): *N/A*
- 9.2.8. Distributed lighting system with one common gas-discharge light source: Yes/No¹ *N/A*
- 9.2.9. Remarks (if any): *N/A*
- 9.2.10. Measures according to paragraph 4.12. of this Regulation: *N/A*
- 9.3. For AFS – Systems
- 9.3.1. Category as described by the relevant marking⁵ *N/A*
- 9.3.2. Number, category and kind of light source(s) *N/A*
- 9.3.2.1. Number and specific identification code(s) of LED module(s) and for each LED module a statement whether it is replaceable or not: yes/no¹ *N/A*
- 9.3.2.2. Number and specific identification code(s) of electronic light source control gear(s), if applicable *N/A*
- 9.3.2.3. Total objective luminous flux as described in paragraph 4.5.2.6. of This Regulation exceeds 2,000 lumen: yes/no¹ *N/A*



Approval No: E24*149R00/05*0558*00

- 9.3.3. (a) Indications according to paragraph 5.3.5.1. of this Regulation (which lighting unit(s) provide a "cut-off" as defined in Annex 5 of this Regulation, that projects into a zone extending from 6 degrees left to 4 degrees right and upwards from a horizontal line positioned at 0.8 degree down) N/A
- (b) The adjustment of the "cut-off" has been determined at 10 m / 25 m¹ N/A
- (c) The determination of the minimum sharpness of the "cut-off" has been carried out at 10 m / 25 m¹ N/A
- 9.3.4. The vehicle(s) for which the system is intended as original equipment N/A
- 9.3.5. Whether approval is sought for a system which is not intended to be included as part of the approval of a vehicle type according to UN Regulation No. 48: yes/no¹ N/A
- 9.3.5.1. If in the affirmative: information sufficient to identify the vehicle(s) for which the system is intended N/A
- 9.3.6. Indications according to paragraph 5.3.5.2. of this Regulation (which class E passing beam mode(s), if any, comply with a "data set" of Table 14 of this Regulation) N/A
- 9.3.7. Whether approval is sought for a system intended to be installed on vehicles only, which provide means for a stabilization/limitation of the system's supply: yes/no¹ N/A
- 9.3.8. The adjustment of the "cut-off" has been determined at 10 m / 25 m.¹ N/A
 The determination of the minimum sharpness of the "cut-off" has been Carried out at 10 m / 25 m.¹ N/A
- 9.3.9. The system is designed to provide passing beams of:⁶ N/A
- 9.3.9.1. Class C Class V Class E Class W
- 9.3.9.2. With the following mode(s), identified by the designation(s), if it applies¹⁴

Mode No. C	Mode No. V	Mode No. E	Mode No. W
Mode No. C	Mode No. V	Mode No. E	Mode No. W
Mode No. C	Mode No. V	Mode No. E	Mode No. W

⁵ Indicate the appropriate marking as foreseen according to this Regulation for each installation unit or assembly of installation units.

⁶ Mark with an X where applicable.

⁷ To be extended if more modes are provided.

⁸ To be continued if more units are provided.



NSAI

Approval No: E24*149R00/05*0558*00

9.3.9.3. Where the lighting units indicated below are energized^{5,7,8} for the mode No.

(a) If no bend lighting applies:

Left side No.1 No.3 No.5 No.7 No.9 No.11
Right side No.2 No.4 No.6 No.8 No.10 No.12

(b) If bend lighting of category 1 applies:

Left side No.1 No.3 No.5 No.7 No.9 No.11
Right side No.2 No.4 No.6 No.8 No.10 No.12

(c) if bend lighting of category 2 applies:

Left side No.1 No.3 No.5 No.7 No.9 No.11
Right side No.2 No.4 No.6 No.8 No.10 No.12

9.3.9.4. The lighting units marked below are energized, when the system is in its neutral state^{5,7}

Left side No.1 No.3 No.5 No.7 No.9 No.11
Right side No.2 No.4 No.6 No.8 No.10 No.12

9.3.9.5. The lighting units marked below are energized, when the system is in its traffic change function^{5,6,7}

(a) If no bend lighting applies:

Left side No.1 No.3 No.5 No.7 No.9 No.11
Right side No.2 No.4 No.6 No.8 No.10 No.12

(b) If bend lighting of category 1 applies:

Left side No.1 No.3 No.5 No.7 No.9 No.11
Right side No.2 No.4 No.6 No.8 No.10 No.12

(c) if bend lighting of category 2 applies:

Left side No.1 No.3 No.5 No.7 No.9 No.11
Right side No.2 No.4 No.6 No.8 No.10 No.12

9.3.10. The system is designed to provide a main beam^{5,6,7}:

9.3.10.1. Yes No

9.3.10.2. With the following mode(s), identified by the designation(s), if it applies:

Main beam mode No. M
Main beam mode No. M
Main beam mode No. M

9.3.10.3. Where the lighting units marked below are energized, for mode No.

(a) If no bend lighting applies:

Left side No.1 No.3 No.5 No.7 No.9 No.11
Right side No.2 No.4 No.6 No.8 No.10 No.12

(b) If bend lighting applies:

Left side No.1 No.3 No.5 No.7 No.9 No.11
Right side No.2 No.4 No.6 No.8 No.10 No.12



NSAI

Approval No: E24*149R00/05*0558*00

9.3.10.4. The lighting units marked below are energized, when the system is in its neutral state^{6,8}

Left side No.1 No.3 No.5 No.7 No.9 No.11
Right side No.2 No.4 No.6 No.8 No.10 No.12

9.3.10.5. The system is designed to provide an adaptation of the driving beam for:

Right-Hand and Left-Hand traffic: yes no
Right-Hand traffic only: yes no
Left-Hand traffic only: yes no

9.4. For headlamps of Classes AS, BS, CS, DS and ES1

9.4.1. Category as described by the relevant marking:⁹ *N/A*

9.4.2. Number, category and kind of light source(s), if any: *N/A*

9.4.3. Number and specific identification code(s) of LED modules and for each LED module a statement whether it is replaceable or not: yes/no¹ *N/A*

9.4.4. Number and specific identification code(s) of electronic light source control gear(s), if any: *N/A*

9.4.5. The determination of "cut-off" sharpness yes / no¹ *N/A*

If yes, it was carried out at 10 m / 25 m¹

9.4.6. Trade name and identification number of separate ballast(s) or part(s) of ballast(s): *N/A*

9.4.7. The passing beam light source may/may not¹ be lit simultaneously with the driving beam light source and/or another reciprocally incorporated headlamp. *N/A*

9.4.8. The minimum bank angle(s) to satisfy the requirement of paragraph 5.4.5.2., if any *N/A*

9.4.9. Primary Driving Beam: yes / no¹ *N/A*
Secondary Driving Beam: yes / no¹ *N/A*
The Secondary Driving Beam shall only be operated together with a passing beam or a primary driving beam. *N/A*

⁹ Indicate the appropriate marking selected from the list below:

- | | | | | | |
|-----------|-----------|-----------|------------|------------|------------|
| C-AS, | C-BS, | R-BS, | CR-BS, | C/-BS, | C/R-BS, |
| WC-CS, | C-BS PL, | R-BS PL, | CR-BS PL, | C/-BS PL, | C/R-BS PL, |
| WC/-CS, | WC-DS, | WR-CS, | WR-DS, | WCR-CS, | WCR-DS, |
| WC-DS PL, | WC/-DS, | WC/R-CS, | WC/R-DS, | WC-CS PL, | |
| | WR-CS PL, | WR-DS PL, | WCR-CS PL, | WCR-DS PL, | |



NSAI

Approval No: E24*149R00/05*0558*00

9.5. For front fog lamps Class F3

9.5.1. Class as described by the relevant marking:
(F3, F3/, F3PL, F3/PL)

F3 PL

9.5.2. Number, category and kind of light source(s):

*4*LEDs*

9.5.3 LED module: ~~yes/no~~[†] and for each LED module a statement whether it is replaceable or not: ~~yes~~/no¹

Yes, non-replaceable light source

9.5.4. LED module specific identification code:

N/A

9.5.5. Application of electronic light source control gear:¹⁰ yes/no¹

Supply to the light source:

Yes

Specification of the light source control gear:

N/A

Input voltage:¹¹

13.2V

In the case of an electronic light source control gear not being part of the lamp:

N/A

Output signal specification:

N/A

9.5.6. Colour of light emitted:

White/Selective yellow[†]

9.5.7. Luminous flux of the light source (see paragraph 4.5.2.6.) greater than 2,000 lumens: ~~yes~~/no¹

No

9.5.8. Luminous intensity is variable: ~~yes~~/no¹

No

9.5.9. The determination of the cut-off gradient (if measured) was carried out at ~~10m~~ / 25 m¹

25m

9.6. For cornering lamps

9.6.1. Number, category and kind of light source(s):¹²

N/A

9.6.2. Voltage and wattage:

N/A

WC/CS PL,	WC/-DS PL,	WC/R-CS PL,	WC/R-DS PL,		
WC+-CS,	WC+-DS,	WC+R-CS,	WC+R-DS,	C+-BS,	C+R-BS,
WC+-CS PL,	WC+-DS PL,	WC+R-CS PL,	WC+R-DS PL,	C+-BS PL,	C+R-BS PL
WC-ES,	WR-ES,	WCR-ES,	WC/-ES,	WC/R-ES,	WC-ES PL,
WR-ES PL,	WCR-ES PL,	WC/-ES PL,	WC/R-ES PL		
WC+-ES,	WC+R-ES,	WC+-ES PL,	WC+R-ES PL		

¹⁰ The voltage specifications shall include the tolerances or voltage range as specified by the manufacturer and verified by this approval.

¹¹ The parameters of the input voltage including duty cycle, frequency, pulse shape and peak voltage shall be included.



NSAI

Approval No: E24*149R00/05*0558*00

- 9.6.3. Light source module: yes/no¹ *N/A*
- 9.6.4. Light source module specific identification code: *N/A*
- 9.6.5. Application of an electronic light source control gear:
(a) Being part of the lamp yes/no¹
(b) Being not part of the lamp yes/no¹
- 9.6.6. Input voltage supplied by an electronic light source control gear: *N/A*
- 9.6.7. Electronic light source control gear manufacturer and identification number (when the light source control gear is part of the lamp but is not included into the lamp body): *N/A*
- 9.6.8. Geometrical conditions of installation and relating variations, if any: *N/A*
10. Approval mark(s) position(s): *On the lens*
11. Reason(s) for extension of approval (if applicable): *N/A*
12. Approval granted / ~~extended~~ / ~~refused~~ / ~~withdrawn~~¹ *Granted*
13. Place: *Dublin*
14. Date: *13th June, 2023*
15. Signature: 



16. The list of documents deposited with the Type Approval Authority, which has granted approval is annexed to this communication and may be obtained on request.

¹² For cornering lamps with non-replaceable light sources indicate the number and total wattage of the light sources used.



NSAI

Approval No: **E24*149R00/05*0558*00**

Index to the Information Package

Date of issue:	<i>13th June, 2023</i>
Date of latest amendment:	<i>N/A</i>
Reason for extension/revision	<i>N/A</i>
1. Additional conditions, and advisory notes on legal alternatives	
2. Test report(s)	
- numbers(s):	<i>23-01410-CX-SHA-00</i>
- date of issue:	<i>27.05.2023</i>
- date of latest amendment:	<i>N/A</i>
3. Information document	
- numbers(s):	<i>MS-BWP4-00</i>
- date of issue:	<i>08.05.2023</i>
- date of latest amendment:	<i>N/A</i>
Documentation:	<i>21 pages</i>



Approval No: E24*149R00/05*0558*00

Appendix: **Additional conditions, and advisory notes on legal alternatives**

A: Additional conditions:

1. The lamp, Type *MS-BWP4* shall be marked as prescribed by the regulation.
2. Fitting instructions shall be supplied with each lamp, giving details of any limitations in the use of the lamp.
3. The lamp should be fitted in accordance with the fitting instructions.
4. The attached technical report, with any of its attachments, forms part of this Type Approval certificate.
5. Each individual product from series production shall be to the measurements specified in the attached drawings, and shall be manufactured only from the materials specified in the Approval documents.
6. Changes in the product are permitted only with the explicit permission of NSAI. Breaches of this requirement will lead to a withdrawal of the Type Approval, and in addition may be subject to criminal prosecution.
7. This Type Approval will expire when it is surrendered by the holder, or withdrawn by NSAI, or when the approved type of product no longer conforms to legal requirements. The recall of the Type Approval can be issued by NSAI when the conditions required for the issuing or continuation of the Type Approval are no longer current, or when the Approval holder is in breach of the duties attached to the Type Approval, or when it is established that the approved type no longer meets the requirements of traffic safety.
8. NSAI may at any time check the correct performance of the duties imposed by the grant of this Type Approval, and in order to do so, may make tests, or have tests made.
9. Changes in the company name, address or manufacturing site, as well as in any of the sales or other agents specified in the issuing of the approval must immediately be notified to the NSAI.
10. The duties imposed by the issuing of this certificate are not transferable. The legal protection of third parties is not affected by this certificate.
11. When the manufacture or sale of the vehicle, system, component or separate technical unit has not been started within one year of the date of issue of this certificate, then NSAI is to be informed. This requirement also applies when the manufacture or sale has been halted for more than one year, or when it ought to have been halted for more than one year. The initial commencement of manufacture or sale, or the resumption of manufacture or sale, shall then be notified to NSAI within one month of commencement or resumption.

B : Legal Options

Any objection to the requirements set out in this certificate shall be made within one month of the date of issue. The objection shall be made, in writing, to NSAI in Dublin

Test report No.: 23-01410-CX-SHA-00
Manufacturer: ~~Shanghai Mechatronics Technology Co., Ltd.~~
Type: MS-BWP4



Auto Service

Annex I Reason of Extension

Correction of : N/A

Modification of : N/A

Addition of : N/A

Deletion of : N/A

Annex II Test results

1. Test conditions
 - 1.1. Technical data of the test samples : Two samples were tested.
Marking: Sample No. 1 and Sample No. 2.
For information about the form of the lamp, the position of the reference point and the reference axis, see information document.
 - 1.2. Test procedures used : According to UN Regulation No. 149.00.
 - 1.3. Measuring and test equipment : Fully automatic photometric test system for automobile lamps
EVERFINE PHOTO-E-INFO CO., LTD.
Type GO-HD5
2. Test results
 - 2.1. General Specifications
The front fog lamps are constructed that in normal use, despite the vibrations to which they may then be subjected, their satisfactory operation continues to be ensured and they retain the characteristics. The correct position of the lens is clearly marked and the lens and reflector are so secured as to prevent any rotation during use.

2.2. Test record of the photometric measurements of front fog lamp, Class F3

2.2.1. Sample No. 1, test voltage 13.2V.

No.	Point of the measurement	Limits [cd]		Measured values [cd]		Conclusion
		Min.	Max.	After stability	After 1 min	
1	Point 1	---	85.00	42.12	44.70	Complies
2	Point 2	---	85.00	46.05	48.87	Complies
3	Point 3	---	85.00	36.62	38.87	Complies
4	Point 4	---	85.00	38.92	41.31	Complies
5	Point 5	---	85.00	45.96	48.78	Complies
6	Point 6	---	85.00	48.27	51.23	Complies
7	Point 7	---	85.00	71.21	75.58	Complies
8	Point 8	---	85.00	70.55	74.88	Complies
9	Point 9	---	85.00	65.96	70.00	Complies
10	Point 10	---	85.00	66.19	70.25	Complies
11	Line 1	---	130.00	98.40	104.43	Complies
12	Line 2	---	150.00	111.96	118.82	Complies
13	Line 3	---	245.00	209.40	222.24	Complies
14	Line 4	---	360.00	307.34	326.18	Complies
15	Line 5	---	485.00	412.66	437.96	Complies
16	Line 6 _{min}	2700.00	---	3351.65	3557.13	Complies
17	Line 6 _{max}	---	12000	4709.47	4998.19	Complies
18	Line 7	---	0.5 of Line 6 _{max}	2304.92	2446.23	Complies
19	Line 8L	1100.00	---	3692.24	3918.60	Complies
20	Line 8R	1100.00	---	3882.45	4120.47	Complies
21	Line 9L	450.00	---	2427.45	2576.27	Complies
22	Line 9R	450.00	---	2575.27	2733.15	Complies
23	Zone D	---	12000.00	4835.97	5132.45	Complies
24	2.5D-V	2700.00	---	3645.43	3868.92	Complies

2.2.2. Sample No. 2, test voltage 13.2V.

No.	Point of the measurement	Limits [cd]		Measured values [cd]		Conclusion
		Min.	Max.	After stability	After 1 min	
1	Point 1	---	85.00	43.50	46.06	Complies
2	Point 2	---	85.00	43.26	45.80	Complies
3	Point 3	---	85.00	38.39	40.65	Complies
4	Point 4	---	85.00	40.38	42.75	Complies
5	Point 5	---	85.00	49.54	52.45	Complies
6	Point 6	---	85.00	52.11	55.17	Complies
7	Point 7	---	85.00	61.51	65.12	Complies
8	Point 8	---	85.00	73.51	77.83	Complies
9	Point 9	---	85.00	70.04	74.16	Complies
10	Point 10	---	85.00	57.92	61.32	Complies
11	Line 1	---	130.00	102.64	108.67	Complies
12	Line 2	---	150.00	114.95	121.70	Complies
13	Line 3	---	245.00	214.09	226.67	Complies
14	Line 4	---	360.00	322.28	341.22	Complies
15	Line 5	---	485.00	432.04	457.43	Complies
16	Line 6 _{min}	2700.00	---	3238.77	3429.07	Complies
17	Line 6 _{max}	---	12000	4596.35	4866.42	Complies
18	Line 7	---	0.5 of Line 6 _{max}	2254.97	2387.46	Complies
19	Line 8L	1100.00	---	3702.71	3920.27	Complies
20	Line 8R	1100.00	---	3825.89	4050.69	Complies
21	Line 9L	450.00	---	2318.22	2454.43	Complies
22	Line 9R	450.00	---	2409.13	2550.68	Complies
23	Zone D	---	12000.00	5129.43	5430.82	Complies
24	2.5D-V	2700.00	---	3813.20	4037.25	Complies

2.5. Tests on plastic lens

2.5.1. Test report for plastic material of the lens attached to the manufacturer's information document.

2.5.2. Tests of the complete headlamp incorporating a lens of plastic material.

2.5.2.1. Test of adherence of coatings - Sample No. 2.

- No appreciable impairment of the gridded area – Complies.

2.5.2.2. Resistance to mechanical deterioration of the lens surface - Sample No. 1.

No.	Point of the measurement	Limits [cd]		Measured values [cd]	Conclusion
		Minimum	Maximum		
1	Line 2	---	195.00	134.65	Complies
2	Line 5	---	630.50	454.23	Complies

2.6. Sharpness of the cut-off according to Annex 6 – Sample No. 1

No.	Test item	Limits		Measured Values	Conclusion
		Minimum	Maximum		
1	Sharpness	0.08	---	0.10	Complies

2.7. Linearity of the cut-off according to Annex 6 – Sample No. 1

No.	Test item	Limits[°]		Measured Values[°]	Conclusion
		Minimum	Maximum		
1	Linearity	---	0.20	0.03	Complies

2.8. Test record of LED modules

2.8.1. Test voltage 13.2V.

2.8.1.1. Red Content

	Limit	measured	Conclusion
Front fog lamp	$K_{red} \geq 0.05$	0.0848	Complies

Test report No.: 23-01410-CX-SHA-00
Manufacturer: ~~Changchun American Technology Co., Ltd.~~
Type: MS-BWP4



2.8.1.2. UV-radiation

	Limit	measured	Conclusion
Front fog lamp	$K_{UV} \leq 10^{-5} \text{ W/lm}$	6.53×10^{-7}	Complies

2.8.1.3. Objective Luminous Flux

	Limit		Measured	Conclusion
	Minimum	Maximum		
Front fog lamp	---	---	1076.95 lm	Complies

2.9. Apparent surface

Refer to manufacturer's information document: MS-BWP4-00

- 3. Specimen submitted to test on : 2023-05-08 (YYYY-MM-DD)
- 4. Place and date of the test : Jiangsu Huachen Vehicle Inspection Co., Ltd.
Xihuan Road, Xinqiao, Danbei Town, Danyang
City, Jiangsu Province, China
2023-05-24 to 2023-05-25 (YYYY-MM-DD)

Information document No.: MS-BWP4-00

First application date : May 8, 2023

1. Specification data

Type		MS-BWP4
Function		Front fog lamp
Color		White
Rated	Voltage	12V
	Wattage	18W
Application Regulation ECE		R149.00 Class F3
Category of light source		4*LEDs Non-replaceable light source
Location of marking	Voltage	Marked on housing
	Trade mark	 MORSUN
	Approval mark	Marked on housing
Remark		Application of an electronic light source control gear: Being part of the lamp

2. Construction and material

Construction	Material	Remarks
Lens	PC	Basis-material: Polycarbonate Make: GE Plastics, Japan Type: Lexan LS2 Coating and coating system: Make: Mitsubishi Rayon Co., Ltd. Type: Acryking K101
Housing	Aluminium alloy	Colour: Black
Electrical Wiring	Copper covered with insulation	--

3. Name and address of manufacturer : ~~Worsun Technology Co., Ltd.~~
~~Worsun Technology Co., Ltd.~~
~~Worsun Technology Co., Ltd.~~
~~Worsun Technology Co., Ltd.~~

4. Name and address of the assembly plant : See 3.

5. Name and address of the manufacturer's representative : N/A

6: Apparent surface

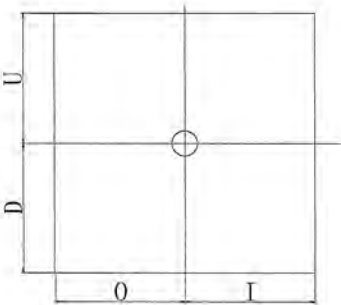
<p>U= Upper limit D= Down limit I= Inside limit O= Outside limit</p>	<p>⊕ :Reference center</p> 			
Unit: mm				
Function	Limit (O)	Limit (I)	Limit (U)	Limit (D)
Front fog lamp	22	22	22	22
--	--	--	--	--

上海海立电器有限公司
 SHANGHAI HAILI ELECTRIC CO., LTD.
 地址：上海市浦东新区川沙新镇川沙路1111号
 电话：021-58900000

Front View

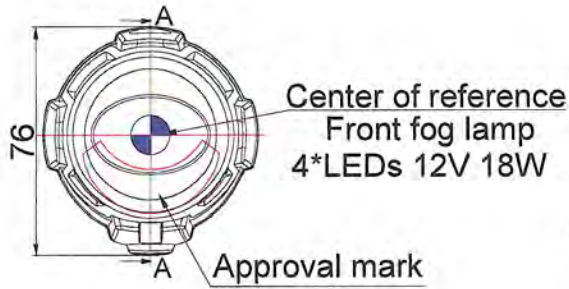

Section A-A

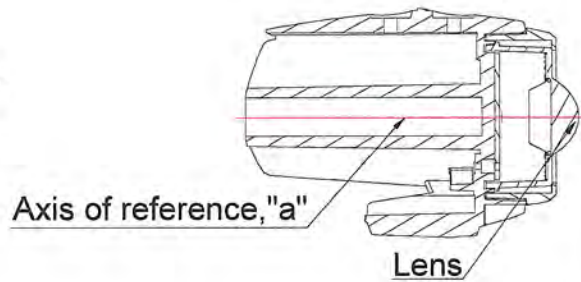

Remove lens View

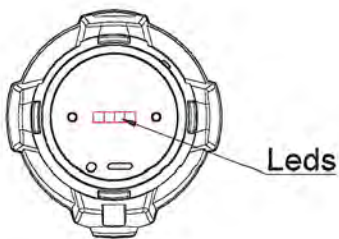

NOTE:

1. "a": Horizontal Plane of Vehicle
2. "b": Longitudinal Plane of Vehicle

Trade mark



MORSUN

Upward View

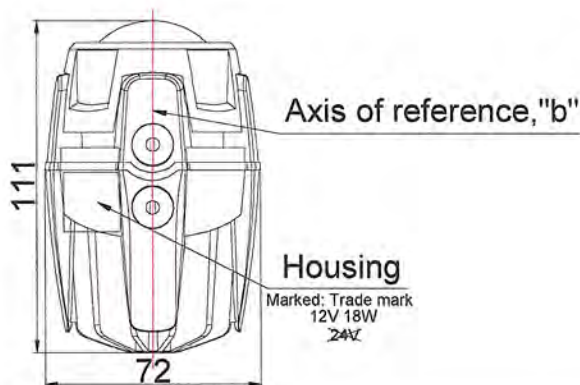

Approval mark



General assembly drawing

Front fog lamp
4*LEDs 12V 18W

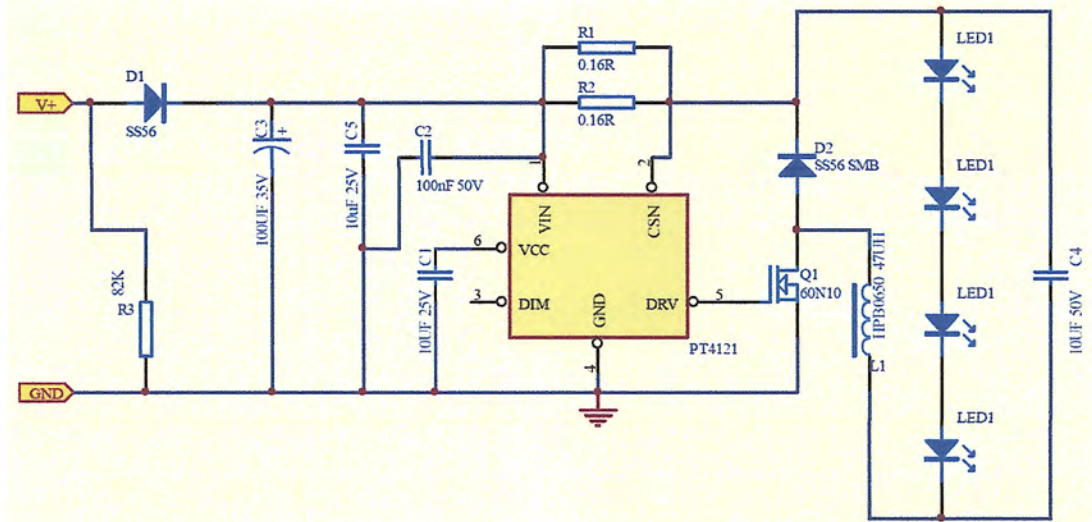

Led circuit diagram

Lens Material - Coating A

UNION TECHNIQUE DE L'AUTOMOBILE DU MOTOCYCLE ET DU CYCLE

DIRECTION ET BUREAUX
157-159 rue Lecourbe
75015 PARIS

CCP. 3022-08 T. PARIS
Tél. (1) 48.42.53.90

CP/NP

LABORATOIRE
Autodrome de Linas-Montlhéry
LINAS - 91310 MONTLHERY
Télécopieur : (1) 69.01.78.45
Télex : UTAC 602 775 F
Tél. (1) 69.01.10.47

PROCES-VERBAL D'ESSAI N° 92.14.60.113/5362

DEMANDEUR : FRANCE MOTORS S.A.R.L
Z. I. Moimont II
95670 MARLY LA VILLE

OBJET DES ESSAIS : Essais de matériaux plastiques présentés par KOITO (LEXAN LS2 revêtus d'ACRYKING K101) réalisés suivant les prescriptions du document TRANS/SC1/WP29/306 concernant les matériaux plastiques destinés à la fabrication des lentilles pour projecteurs automobiles.

CONCLUSION : Les matériaux examinés répondent aux prescriptions du document précité.

MONTLHERY, le 21 Juillet 1992



G. BONNEAU
Service Photométrie



J.Lp. MARDUEL
Directeur des Essais
et de la Réglementation

Ce document contient 7 pages.

N.B. : "Les présents essais ne sauraient en aucune façon engager la responsabilité de l'U.T.A.C. en ce qui concerne les réalisations industrielles ou commerciales qui pourraient en résulter". (Extrait du Règlement Général des essais).
Seule est autorisée la reproduction intégrale de ce document.

E24*149R00/05*0558*00

1 - MATERIAUX SOUMIS AUX ESSAIS -. Nature des matériaux

- Fabricant : KOITO MANUFACTURING CO LTD
JAPON

- Description des matériaux fournie par le demandeur :

- . matériau de base :
type : polycarbonate
référence : LEXAN LS2
fabricant : GE plastics, Japan
- . revêtement :
référence : acryking K101
fabricant : MITSUBISHI RAYON CO LTD
- . méthode de fabrication :
matériau de base injecté, dépôt du revêtement par bain

. Echantillons soumis au laboratoire :

12 plaques n^{os} UTAC : 6.2544 à 6.2555
3 lentilles n^{os} UTAC : 6.2581 à 6.2583
1 réflecteur (projecteur KOITO 110-61639 type H4)

2 - ESSAIS -

Les échantillons ont été soumis aux essais décrits dans le document TRANS/SC1/WP29/306 paragraphes :

- 2-1 - Essai de résistance aux changements de température.
- 2-2 - Essai de résistance aux agents atmosphériques et aux agents chimiques.
- 2-3 - Essai de résistance aux détergents et aux hydrocarbures.
- 2-4 - Essai de résistance à la détérioration mécanique.
- 2-5 - Essai d'adhérence du revêtement.

3 - RESULTATS DES ESSAIS -

3-1 - Essai de résistance aux changements de température :

Les lentilles repérées n°^S 6.2581/82/83, ont été montées sur le réflecteur et les mesures photométriques ont été effectuées dans les conditions prescrites.

Les 3 lentilles ont ensuite été soumises aux cycles de changement de température et d'humidité, puis remontées sur le réflecteur pour le contrôle photométrique.

Les résultats sont indiqués dans le tableau 1 ci-dessous :

Lentilles n°	E mesurés en lux *			Valeurs exigées en lux	
	6.2581	6.2582	6.2583		
B 50	Avant	0,23	0,24	0,23	≤ 0,4
	Après	0,25	0,26	0,25	
	Ecart	8,7 %	7,6 %	8,7 %	
50 R	Avant	20,9	20,9	20,8	≥ 12
	Après	19,4	19,5	20,1	
	Ecart	7,1 %	6,7 %	3,4 %	
E MAX Route	Avant	81,6	82,1	81,5	48 ≤ E ≤ 240
	Après	84,9	84,3	81,8	
	Ecart	4,0 %	2,6 %	0,4 %	

* Avec lampe étalon H4 E801/91C/R

3-2 - Essai de résistance aux agents atmosphériques et aux agents chimiques

Trois échantillons repérés n°s 6.2544/45/46 ont été mesurés en transmission (t2/t1).

Ils ont ensuite été exposés au rayonnement d'une source dans les conditions prescrites dans le projet de Règlement jusqu'à ce qu'ils reçoivent une énergie correspondant à 4500 MJ/m², soit 1000 h dans le weather-ometer.

Après cette exposition, les échantillons ont été examinés, mesurés en transmission (t3/t1) et en diffusion (t4/t1), et soumis aux agents chimiques.

Après cet essai, la valeur de la diffusion a de nouveau été mesurée (t5/t1).

Les résultats sont indiqués dans le tableau 2 ci-dessous.

Tableau 2 -

ECHANTILLONS	VALEURS MESUREES				VALEURS EXIGEEES
	6.2544	6.2545	6.2546	Moy.	
Transmission t2/t1	0,893	0,891	0,890		
Essai agents atmosphériques					
Transmission t3/t1	0,891	0,890	0,888		
Δ t	0,002	0,001	0,002	0,002	Δ tm ≤ 0,020
Diffusion t4/t1	0,001	0,001	0,001		
Essai agents chimiques					
Diffusion t5/t1	0,003	0,004	0,004		
Δ d	0,002	0,003	0,003	0,003	Δ dm ≤ 0,020

3-3 - Essai de résistance aux détergents et aux hydrocarbures :

Trois échantillons repérés n°s 6.2547/48/49 ont été mesurés en transmission (t2/t1) et ont ensuite été soumis à l'action des détergents et des hydrocarbures.

Après cet essai, la valeur de la transmission a de nouveau été mesurée (t3/t1).

Les résultats sont indiqués dans le tableau 3 ci-dessous :

Tableau 3 -

ECHANTILLONS	VALEURS MESUREES				VALEURS EXIGÉES
	6.2547	6.2548	6.2549	Moy.	
Transmission t2/t1	0,891	0,892	0,891		
Essai détergents et hydrocarbures					
Transmission t3/t1	0,890	0,890	0,891		
Δt	0,001	0,002	0	0,001	$\Delta t_m \leq 0,010$

3-4 - Essai de résistance à la détérioration mécanique :

Trois échantillons repérés n°s 6.2553/54/55 ont été mesurés en transmission (t2/t1) et en diffusion (t4/t1).

Ils ont ensuite été soumis à l'essai de détérioration mécanique uniforme par projection de sable comme décrit dans le projet de Règlement.

Après cet essai, les échantillons ont à nouveau été mesurés en transmission (t3/t1) et en diffusion (t5/t1).

Les résultats sont indiqués dans le tableau 4 ci-dessous :

Tableau 4 -

ECHANTILLONS	VALEURS MESUREES				VALEURS EXIGÉES
	6.2553	6.2554	6.2555	Moy.	
Transmission t2/t1	0,889	0,889	0,888		
Diffusion t4/t1	0,001	0,001	0,001		
Essai de détérioration					
Transmission t3/t1	0,873	0,876	0,865		
Diffusion t5/t1	0,026	0,023	0,032		
Δ t	0,016	0,013	0,023	0,017	Δ tm ≤ 0,100
Δ d	0,025	0,022	0,031	0,026	Δ dm ≤ 0,050